

ANGLE:	LOCATION:	DESCRIPTION:
0°	SHELL, UP 6"	2" MNPT NIPPLE
0°	SHELL, TBD	LIFTING LUG W/REPAD
0°	SHELL, TBD	LIFTING LUG W/REPAD
45°	BOTTOM	ANCHOR CHAIR
90°	TOP, 24" RADIUS	2" MNPT NIPPLE
90°	SHELL, DOWN 8"	ERECTION LUG W/REPAD

ALL BOLT HOLES TO STRADDLE MAJOR CENTERLINES OR THEIR PARALLELS

ANGLE:	LOCATION:	DESCRIPTION:
135°	BOTTOM	ANCHOR CHAIR
180°	TOP, 24" RADIUS	2" MNPT NIPPLE
225°	BOTTOM	ANCHOR CHAIR
270°	SHELL, DOWN 8"	ERECTION LUG W/REPAD
270°	TOP, 20" RADIUS	18" STANDARD MANWAY
315°	BOTTOM	ANCHOR CHAIR
N/A	TOP, CENTER	6" GOOSENECK VENT

**ALL WELDS DOUBLE BUTT  
W/FULL PENETRATION**

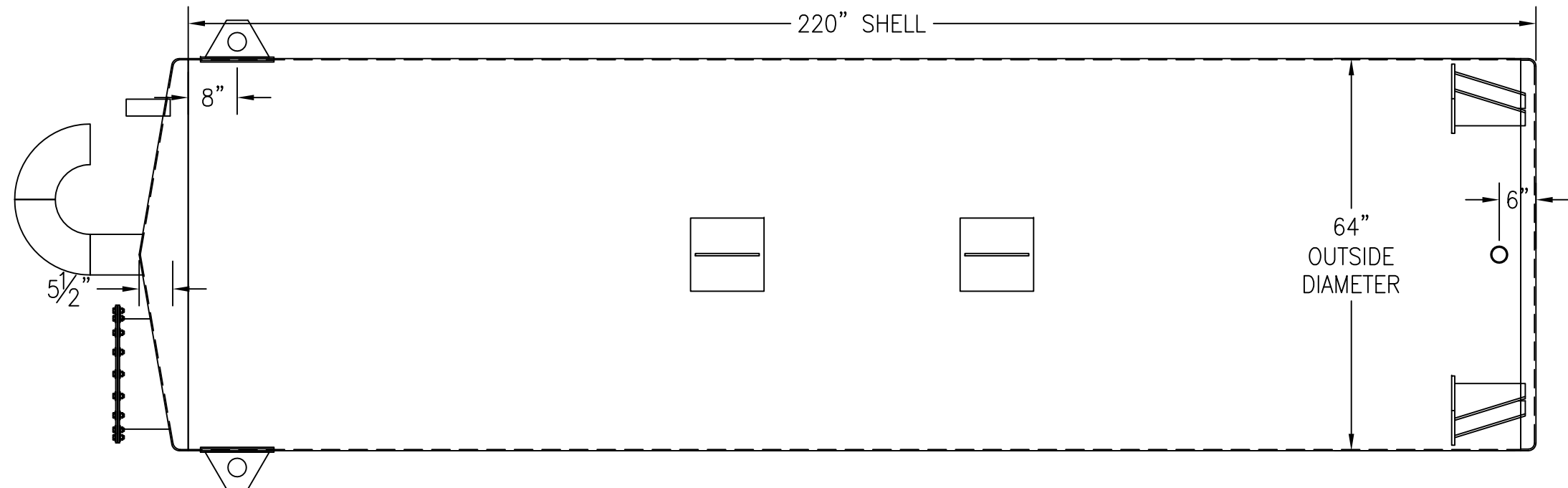
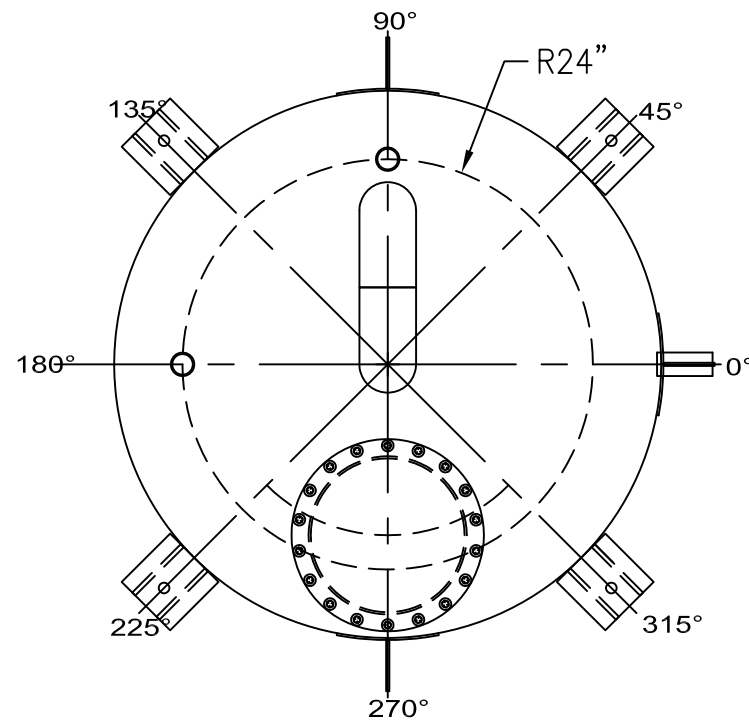

CUSTOMER APPROVAL SIGNATURE/DATE:

**3000 GALLON VERTICAL S/W ABOVE GROUND NON-POTABLE WATER STORAGE TANK**

**SURFACE PREPARATION/COATING INFORMATION:**

INTERIOR SURFACES: SSPC-SP-10 NEAR WHITE BLAST  
TWO COATS EPOXY

EXTERIOR SURFACES:  
SSPC-SP-6 COMMERCIAL BLAST CLEAN  
ONE COAT WHITE URETHANE

**MATERIAL /CONSTRUCTION/ LABELING INFORMATION:**

MATERIAL: CARBON STEEL ASTM A 36 OR ASTM A 569  
MATERIAL THICKNESS: TANK TOP & SHELL: 3/16" BOTTOM: 1/4"

LABELING/MARKING:

CUSTOMER:

PROJECT:

AGENT:



P.O. BOX 1279 GOLDSBORO, NC 27533  
PHONE: (919)751-1791 FAX: (919)751-8186

DRAWING NUMBER:

**GIWV-NP-0364**

11/2014

QUANTITY: ONE (1) REQUIRED  
WEIGHT: 4,500 lbs ± 10%